

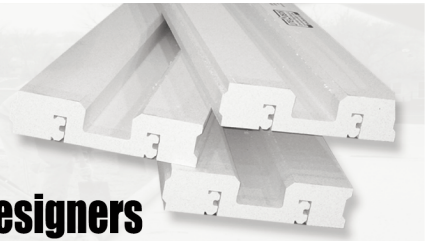

# LITE-DECK

## Concrete Deck/Floor

### Basic Installation Guide Details for Builders and Designers



#### General Information

**REVISED JUNE 2008**

**Warning** - Serious injury or death may result from safety hazards caused by improper use or installation. When in doubt about proper use or installation of Lite-Deck, immediately contact your project's Structural Engineer or your Lite-Deck supplier for clarification. Before beginning, check local engineering and building codes on cast-in-place, joisted concrete construction. The instructions in this manual cover basic building situations and are not meant to replace job-specific codes for the engineering or safety for a specific project.

The Lite-Deck system described in this manual requires appropriate bracing and shoring to properly support the form work during the placement of concrete. This manual covers basic bracing and shoring and is not meant to replace job-specific requirements. **Installer is responsible for the design and correct installation of shoring of Lite-Deck forms in accordance with the latest ACI (American Concrete Institute) 347R "Guide to Formwork for Concrete"**. Any variance from these standards must be provided and certified in advance by a structural engineer, licensed for the jobsite location, type and specifications.

The Lite-Deck system described in this manual requires appropriate steel reinforcing to properly support the dead loads, live loads and clearspans required. This manual covers basic reinforcing and is not meant to replace job-specific requirements. **Installer is responsible for placement of all reinforcing steel in accordance with the latest ACI (American Concrete Institute) 318 "Building Code Requirements for Reinforced Concrete"**. Any variance from these standards must be provided and certified in advance by a Structural Engineer, licensed for the jobsite, type and specifications.

**Changes and Revisions** - Lite-Form Technologies reserves the right to change product design, safe working loads, product dimensions or installation techniques at any time without prior notice to users.

**Interchangeability** - The Lite-Deck forms and the placed concrete will, in most cases, require the application of a finish or cover material which is not manufactured or supplied by Lite-Form International. Installers are instructed to follow the manufacturer's recommendations for the proper use of those products and/or systems in conjunction with Lite-Deck. Although certain types of finishes and covers are mentioned in this manual, Lite-Form Technologies does not recommend or endorse any particular finishing material or system.

**Warranty** - Lite-Form Technologies, "the company" will refund the price of or replace, at its election, any Lite-Deck component which it finds to be defective provided the product has been used properly. **Except as expressly stated above, the Company makes no warranty of fitness for any particular purpose nor does it make any warranty, expressed or implied, of any nature whatsoever with respect to the product or the use thereof, by the way of illustration and example. In no event shall the Company be liable for delays caused by defects, for loss of use or for indirect, special or consequential damages, or for any charges or expenses of any nature incurred without its written consent.** The foregoing is the full extent of the responsibility of the Company even though the Company may have been negligent

Manufactured & Distributed under license by: Lite-Form International - 1950 W. 29th St. - South Sioux City, NE 68776 - Phone Toll Free in North America: 1-800-551-3313

**YOUR LITE-DECK SECTIONS-** Lite-Deck's Top Hat design lets you custom assemble the forms on the jobsite, to produce the appropriate load-bearing concrete joist. **Six-inch Base Section** is supplied in custom lengths and should not require field cutting. **Four-foot wide** sections are normally supplied for form lengths up to 24 feet. **Two-foot wide** sections are supplied for form lengths over 24-feet. If Base Sections must be trimmed or cut, this can be done with a reciprocating saw.

**TOP HAT SECTIONS** are supplied in 3 different sizes (2", 4" or 6" thick). To create finished joist depths **over 6-inches**, they are attached to the Base Sections. They are supplied in standard 8-foot lengths and can be cut or trimmed with a manual or power saw. One or more Top Hat sizes are combined, to create a wide variety of finished joist depths.

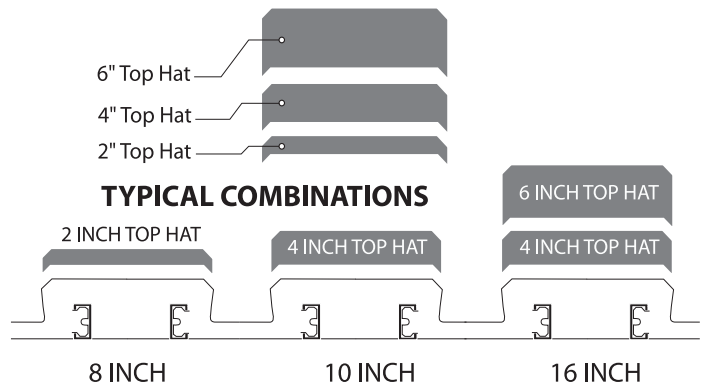
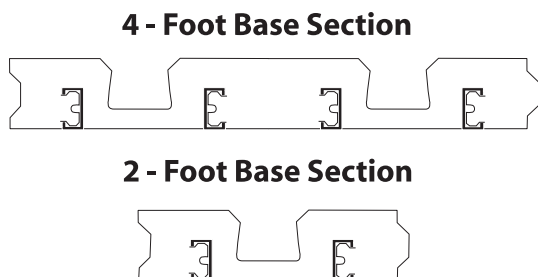

## MATERIALS AND TOOLS YOU NEED

- Good quality 2x4 and 2x6 dimensional lumber
- Lengths of 1 1/2" steel punch bar
- Approved shoring system (2 examples are illustrated)
- Various screws as detailed in manual
- 16 gauge wire

## STEP 1 INSTALL INTERIOR PERIMETER BRACING

Interior Perimeter bracing is placed horizontally at the top of the interior sides of the walls, on both ends of the Lite-Deck sections, perpendicular to the Lite-Deck steel C channels.

*DIAGRAM A and DIAGRAM B.*

- Attach lengths of 1.5" steel punch bar to 2x4 wood stud, using 1 1/4" long pan head screws, placed approx. 16" apart.
- Place bracing flush with top of wall, continuously on both ends. Anchor wood stud to wall, every 16" to 24" with masonry screws or nails when anchoring to masonry walls. Use drywall screws when anchoring to an insulating concrete form's furring strips or pads.
- Reinforce the brace by installing good quality 2x4 wood studs vertically, every 4' to 6'. **Vertical studs will carry the weight of concrete placement!** So, it must be securely anchored to the wall approx. 3' apart and toenailed to horizontal brace at top.

**DIAGRAM A**  
Interior Perimeter Bracing

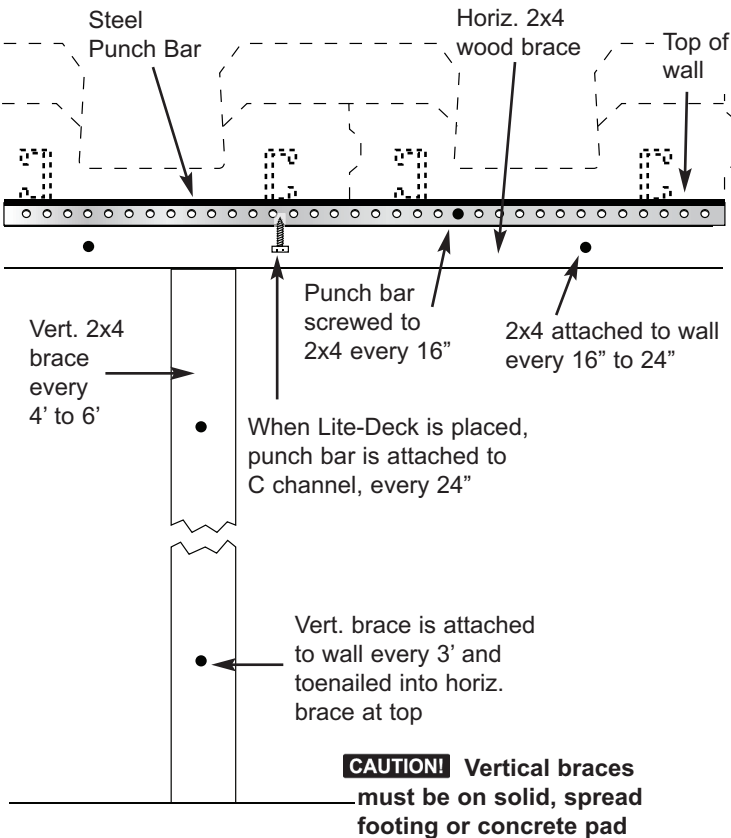

## STEP 2 INSTALL TEMPORARY SHORING

Temporary shoring is used to carry the majority of the weight, as concrete is placed. It must be placed in accordance with a licensed Structural Engineers job-specific guideline or in accordance with the latest ACI (American Concrete Institute) 347R "Guide to Formwork for Concrete". Continuous shoring is placed perpendicular to the Lite-Deck sections and spaced 6 feet apart. Adjustable, pre-rated shoring systems are strongly recommended and can be purchased or rented, as needed. **If non-rated shoring materials are used, a Structural Engineer can provide guidance on the load bearing capacities of various shoring materials.** Two types of shoring techniques are illustrated. *DIAGRAM B and DIAGRAM C.*

- Any span farther than 6 feet must have temporary shoring supporting it
- Adjust shoring height to compensate for any required camber
- Shoring must be on solid, spreader footing or concrete pad
- If permanent joists will be supporting Lite-Deck sections, they must be certified by a structural engineer, to support the combined dead and live loads.

**CAUTION!** Diagrams in this manual do not show complete and proper reinforcing steel (rebar) placement. Project-specific engineering plans or local building codes must be followed.



Lite-Deck sections are being placed on top of a solid, insulated concrete basement. The interior perimeter bracing and shoring (perpendicular to the clear span) has been placed. Note the vertical reinforcing steel which has been cast into the basement walls. That steel will be structurally integrated into reinforcing steel used for the Lite-Deck floor.

**Caution!** In windy conditions, it may be necessary to weight the sections.

**Caution!** Do not step onto the joist portion of sections.

**Caution!**

**Workers should not be under sections while they are being placed, while rebar is being placed or during concrete placement.**

**DIAGRAM B**  
Temporary Shoring using adjustable, load-rated system

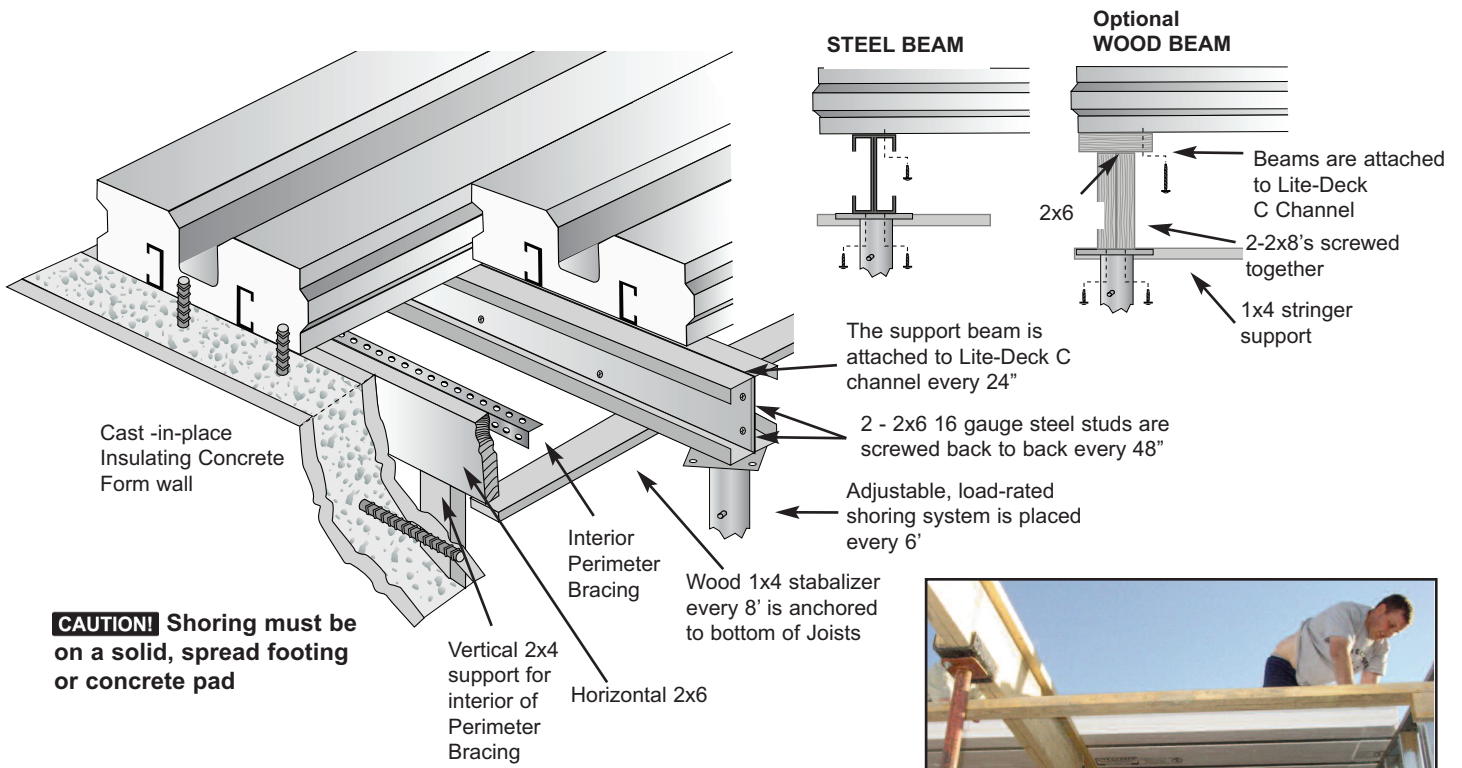

**DIAGRAM C**  
Temporary Shoring with Floor Joists & Dimensional Lumber

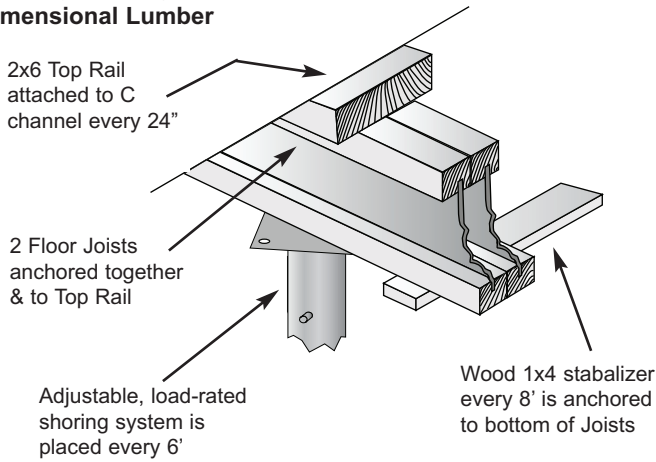

**STEP 4 ATTACHING TOP HATS**

Top Hat Sections should be anchored (attached) prior to placing reinforcing steel. Insert 6" to 10" lengths of heavy wire (skewers) diagonally, through the Top Hat, into the Base Section. Place anchors prox. Every 4 feet. Continuous applications of glue or double-sided tape, which has been approved for use on rigid Polystyrene insulation, can also be used to anchor Top Hats.



Foam glue is used to attach top-hats to the base section.

**STEP 3 PLACE LITE-DECK SECTIONS**

With bracing and shoring in place, sections can be placed snugly together. *DIAGRAM B.*  
- Anchor steel punch bar to Lite-Deck steel C channels with 1 1/4" self-tapping pan head screws every 24".

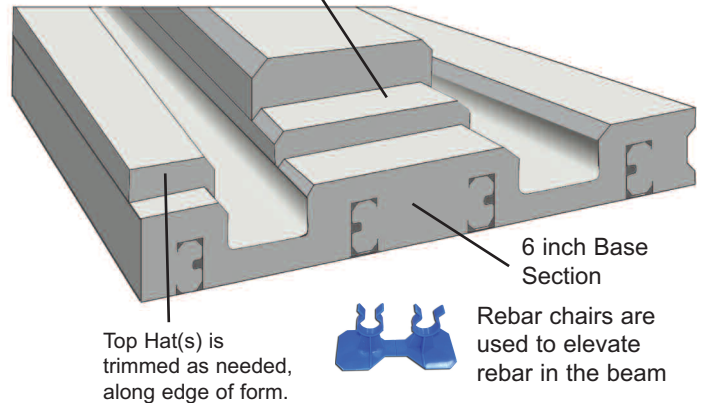

## STEP 5 INSTALL OUTER PERIMETER BRACING

Outer bracing is installed to contain the concrete during placement. The bracing material can be rigid polystyrene or dimensional lumber. The “rebar and wire” techniques for holding it in proper alignment is illustrated. However, your Structural Engineer or Lite-Deck supplier may suggest other anchoring systems.

### DIAGRAM D

- The 2x4 outer rail is used to keep bracing in proper alignment
- Install anchors using 20” lengths of #4 rebar and 16-gauge wire.
- Anchors are placed approx. 6” back from edge of Lite-Deck sections
- Place anchors 4’ apart, on all sides

### DIAGRAM D

#### Outer Perimeter Bracing for Insulating Concrete Form Walls

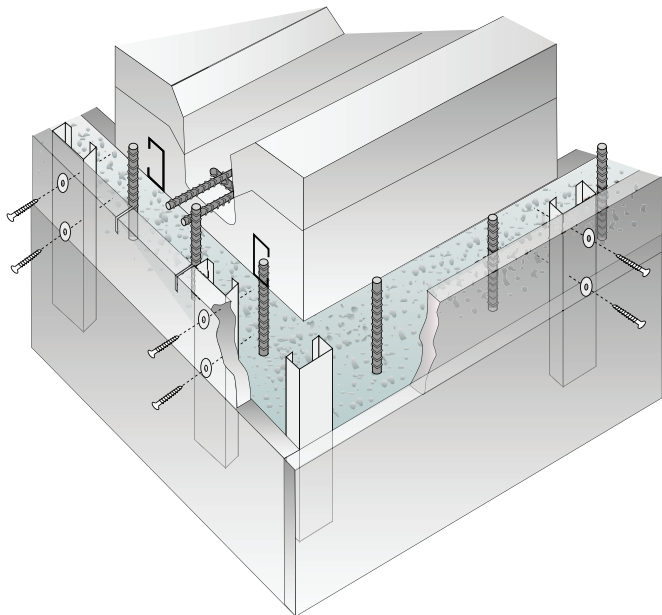

#### STYLE II:

Rigid insulation planks are attached with wood cleats, using drywall screws and insulation washers. Place cleats approx. 24” apart. Expandable foam can assist when placing this outer piece of foam.

## STEP 6 INSTALL REINFORCING STEEL

- Reinforcing steel (rebar) must be placed in accordance with a licensed Structural Engineer’s job-specific guideline or in accordance with current ACI (American Concrete Institute) 318-99 Building Code Requirements for Reinforced Concrete. Rebar is normally placed in the joist cavity, at the perimeter and within the concrete cover. The rebar shown in this manual is not intended to be a structural engineering guideline for actual placement

### DIAGRAM D.

**CAUTION! WORKERS MUST NOT BE UNDER SECTIONS WHILE CONCRETE IS BEING PLACED!**

**Workers should observe placement from a safe distance.**

**If shoring/bracing shifts or fails, placement can be immediately stopped.**

 **LITE-DECK**®

- Prior to placing the rebar, mesh or in-floor heating in the concrete cover, the outer perimeter bracing should be installed.

## STEP 7 INSTALL MESH AND IN-FLOOR HEATING SYSTEM FOR CONCRETE COVER

- Once the outer perimeter bracing has been secured, reinforcing mesh or rebar can be placed for the concrete cover. Follow the guidelines provided by your licensed Structural Engineer or install in accordance with ACI Standards mentioned in this manual. If systems such as in-floor heating are to be installed, follow the manufacturer’s guidelines for proper installation.

## STEP 8 CONCRETE PLACEMENT

The following concrete specifications are only suggestions. Specifications from your licensed Structural Engineer or local building code office should be followed, if they are different:

- Start by placing concrete in the joists
- Concrete can be placed with pump, out of truck or with wheelbarrow\*\*

- Avoid excessive concentrations of crew or piles of concrete

- Typical concrete specifications:

- 4-6 inch slump
- 4,000 to 5,000 psi
- 1/2 to 3/4 inch smooth aggregate

- Must be finished at time of placement...manually or with power float

- Should be consolidated by vibrating

Concrete placement must be in accord with ACI (American Concrete Institute) codes 305 and 306 (hot and cold weather placement) and code 301 for structural concrete.

**\*\*Supplier must be able to provide concrete in a timely manner and plans must be made for an alternate method of concrete placement in the event of equipment failure. Concrete must be placed in a single operation. Any cold joints in joists or cover could result in structural failure of the installation.**

## STEP 9 REMOVING BRACES

- Wait a minimum of 21 days or until concrete has reached 75% of design strength (through hydration) before removing temporary shoring or bracing. A simple “cylinder” test can be done by a local testing facility to determine the design strength at any time.